

FEATURES

- High output voltage 12 V_{pp}
- High gain 35 dB
- High SNR
- Single voltage power supply

APPLICATIONS

- LiNbO₃ & InP modulators
- 12 Gbps DPSK
- 2x12 Gbps (D)QPSK
- Research & Development

OPTIONS

- Heat-sink

The DR-DG-10-HO is a driver module optimized for digital applications requiring an upper operation voltage at 12.5 Gbps. It exhibits 12.5 V_{pp} output voltage and 35 dB gain up to 7 GHz.

The DR-DG-10-HO module is especially useful for driving LiNbO₃ modulators with 12 Gbps DPSK and 2 x 12 Gbps (D)QPSK modulation formats.

It is also a key device for multi-level modulation formats and for driving phase modulators. It is operated from a single power supply voltage for safety and ease of use and offers output voltage control. The DR-DG-10-HO comes with SMA type RF connectors (female in, male out) and with an optional heat sink. It is a non-inverting and single ended amplifier.

Performance Highlights

Parameter	Min	Typ	Max	Unit
Cut-off Frequencies	50 k	-	8 G	Hz
Output Voltage	-	12	-	V _{pp}
Gain	-	30	-	dB
Saturated Power	-	26	-	dBm
Added Jitter	-	1.25	-	ps
Rise / Fall Times	-	24.5	-	ps

Measurements for V_{bias} = 12 V, V_{amp} = 1.2 V, I_{bias} = 420 mA

12.5 Gbps Output Response

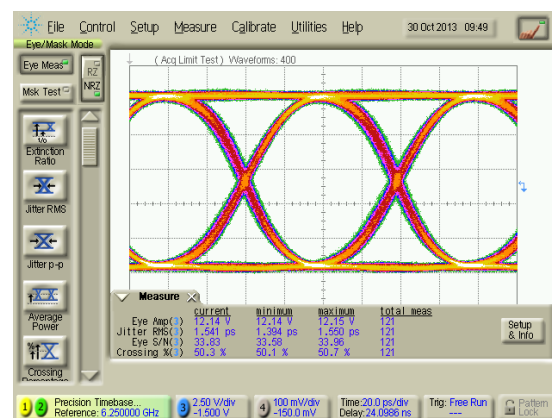

DC Electrical Characteristics

Parameter	Symbol	Min	Typ	Max	Unit
Supply voltage (fixed)	V_{bias}	-	12	-	V
Current consumption	I_{bias}	-	0.420	-	A
Gain control voltage	V_{amp}	0	1.4	-	V

Electrical Characteristics

Parameter	Symbol	Condition	Min	Typ	Max	Unit
Lower frequency	f_{3dB}^{lower}	-3 dB point	45	50	-	kHz
Upper frequency	f_{3dB}^{upper}	-3 dB point	6	8	-	GHz
Gain	S_{21}	Small signal	-	30	-	dB
Gain ripple	-	< 8 GHz	-	±1.5	-	dB
Input return loss	S_{11}	10 MHz < f < 10 GHz	-	-10	-	dB
Output return loss	S_{22}	10 MHz < f < 10 GHz	-	-10	-	dB
Output voltage	V_{out}	$V_{in} = 0.5 V_{pp}$ @ 10.7 Gbps	6	12	12.5	V_{pp}
Rise time / Fall time	t_r / t_f	20 % - 80 %	-	24.5 / 24.5	-	ps
Added jitter	J_{RMS}	$J_{RMS} = \sqrt{J_{RMS-total}^2 - J_{RMS-source}^2}$	-	1.25	-	ps
Power dissipation	P	$V_{out} = 12 V_{pp}$	-	5	-	W

Conditions: $V_{in} = 0.5 V_{pp}$, $T_{amb} = 25^\circ\text{C}$, 50 Ω system

Absolute Maximum Ratings

Stresses in excess of the absolute maximum ratings can cause permanent damage to the device. These are absolute stress ratings only. Functional operation of the device is not implied at these or any other conditions in excess of those given in the operational sections of the data sheet. Exposure to absolute maximum ratings for extended periods can adversely affect device reliability.

Parameter	Symbol	Min	Max	Unit
RF input voltage	V_{in}	-	1	V_{pp}
Power Supply Voltage	V_{bias}	11.5	13	V
DC current	I_{bias}	-	0.45	A
Gain control voltage	V_{amp}	0	2	V
Power dissipation	P_{diss}	-	5.8	W
Temperature of operation	T_{op}	-5	+50	$^\circ\text{C}$
Storage temperature	T_{st}	-40	+70	$^\circ\text{C}$

S₂₁ Parameter Curve

Conditions: $V_{bias} = 12\text{ V}$, $V_{amp} = 0.6\text{ V}$, $I_{bias} = 455\text{ mA}$

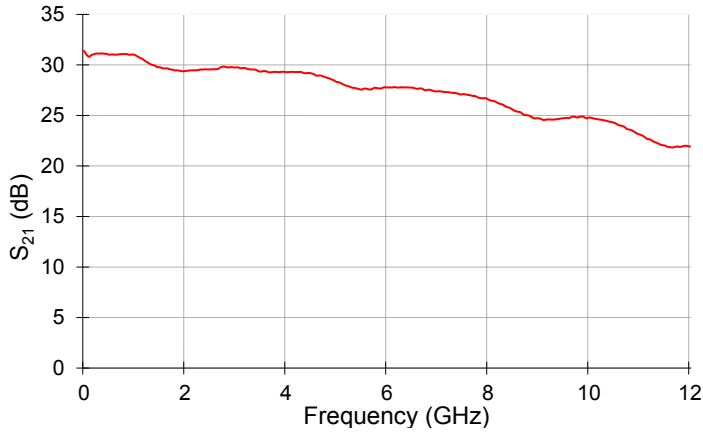

Group Delay Parameter Curve

Conditions: $V_{bias} = 12\text{ V}$, $V_{amp} = 0.6\text{ V}$, $I_{bias} = 455\text{ mA}$

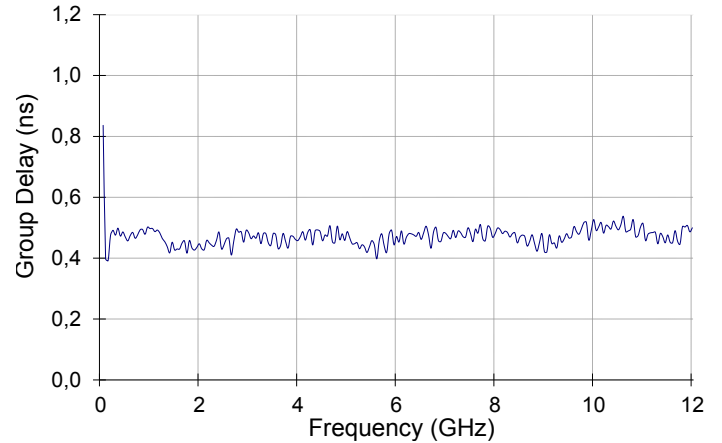

S₂₂ Parameter Curve

Conditions: $V_{bias} = 12\text{ V}$, $V_{amp} = 0.65\text{ V}$, $V_{xp} = 1\text{ V}$, $I_{bias} = 319\text{ mA}$

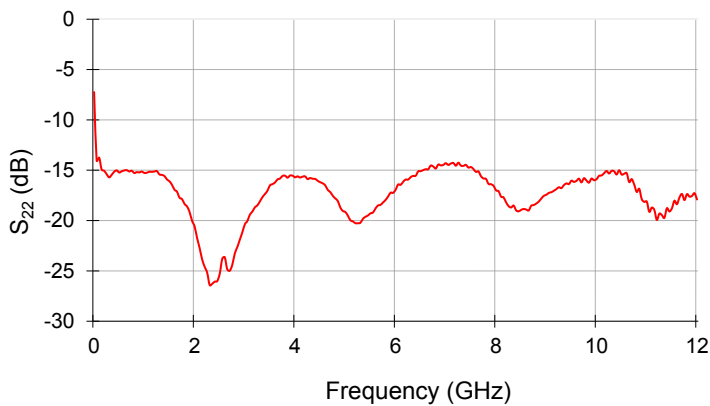

S₁₁ Parameter Curve

Conditions: $V_{bias} = 12\text{ V}$, $V_{amp} = 0.6\text{ V}$, $I_{bias} = 455\text{ mA}$

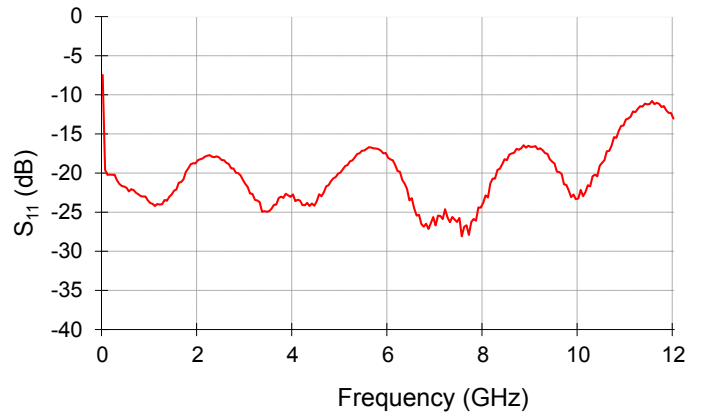

S₁₂ Parameter Curve

Conditions: $V_{bias} = 12\text{ V}$, $V_{amp} = 0.6\text{ V}$, $I_{bias} = 455\text{ mA}$

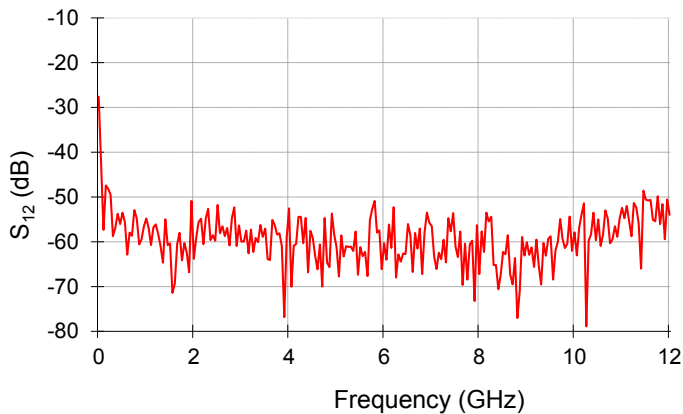

Typical Output Voltage Amplitude vs V_{amp}

Conditions: $V_{bias} = 12\text{ V}$, $V_{amp} = 0.6\text{ V}$, $I_{bias} = 455\text{ mA}$

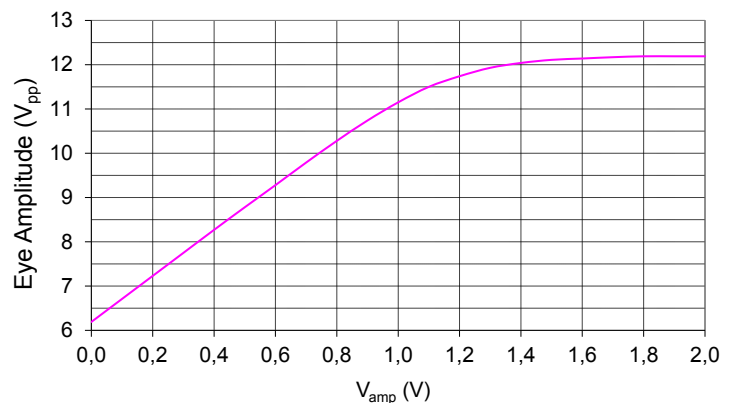

Eye Diagrams

10 Gbps data rate

Conditions: Ratio y, Pattern 2³¹-1

$V_{bias} = 12\text{ V}$, $V_{amp} = 1.35\text{ V}$, $I_{bias} = 379\text{ mA}$

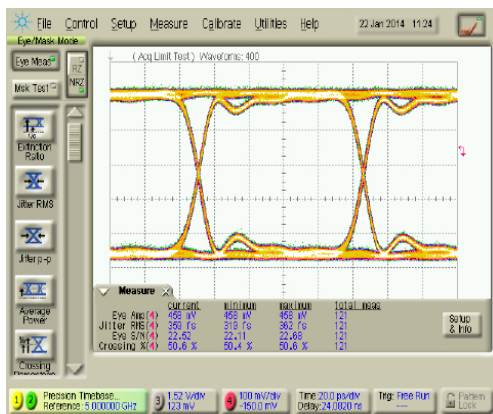

Input signal

Eye amplitude = 0.458 V, Rise time = 10 ps
Jitter RMS = 359 fs, SNR = 22.5

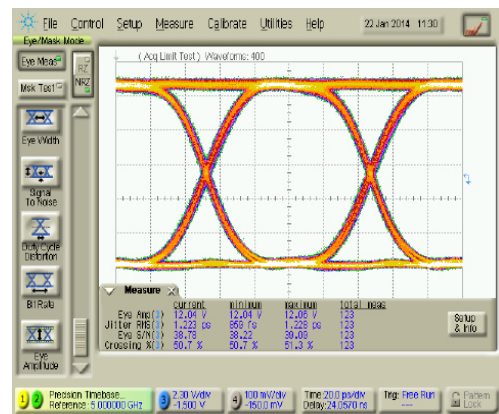

Output response

Eye amplitude = 12 V, Rise time = 26 ps
Jitter RMS = 1.23 ps, SNR = 38.8

12.5 Gbps data rate

Conditions: Ratio y, Pattern 2³¹-1

$V_{bias} = 12\text{ V}$, $V_{amp} = 1.7\text{ V}$, $I_{bias} = 400\text{ mA}$

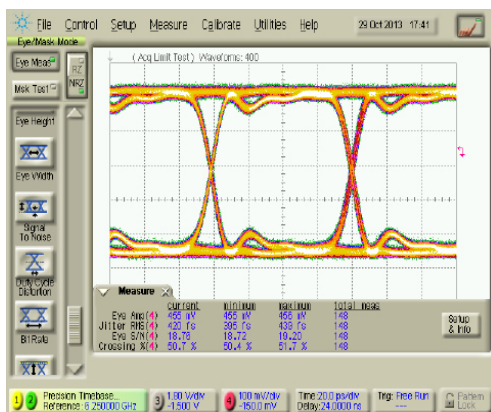

Input signal

Eye amplitude = 0.455 V, Rise time = 10 ps
Jitter RMS = 420 fs, SNR = 18.8

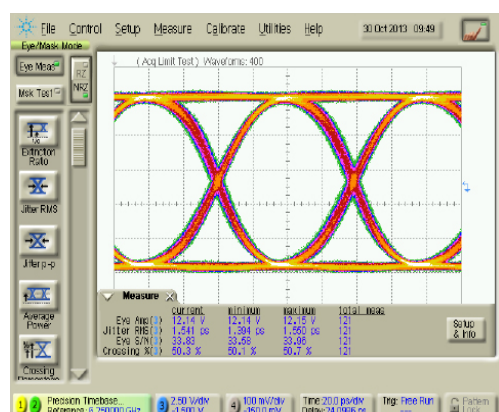

Output response

Eye amplitude = 12.14 V, Rise time = 24.9 ps
Jitter RMS = 1.5 ps, SNR = 33.8

Electrical Schematic Diagram

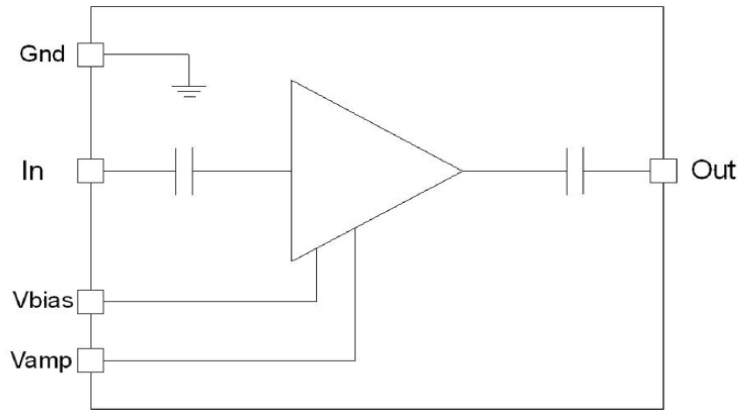

Mechanical Diagram and Pinout

All measurements in mm

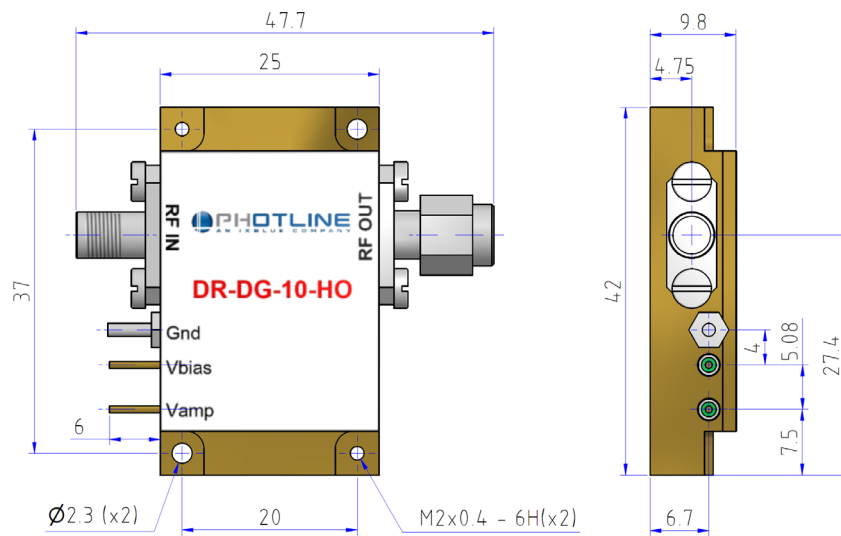

The heatsinking of the module is necessary. It's user responsibility to use an adequate heatsink. Refer to page 6 for iXBlue recommended heatsink.

PIN	Function	Unit
IN	RF In	SMA - connector female
OUT	RF Out	SMA - connector male
V_{bias}	Power supply voltage	Set a typical operating specification
V_{amp}	Output voltage amplitude adjustment	Adjust for gain control tuning

Mechanical Diagram And Pinout With HS-HO1 Heatsink

All measurements in mm

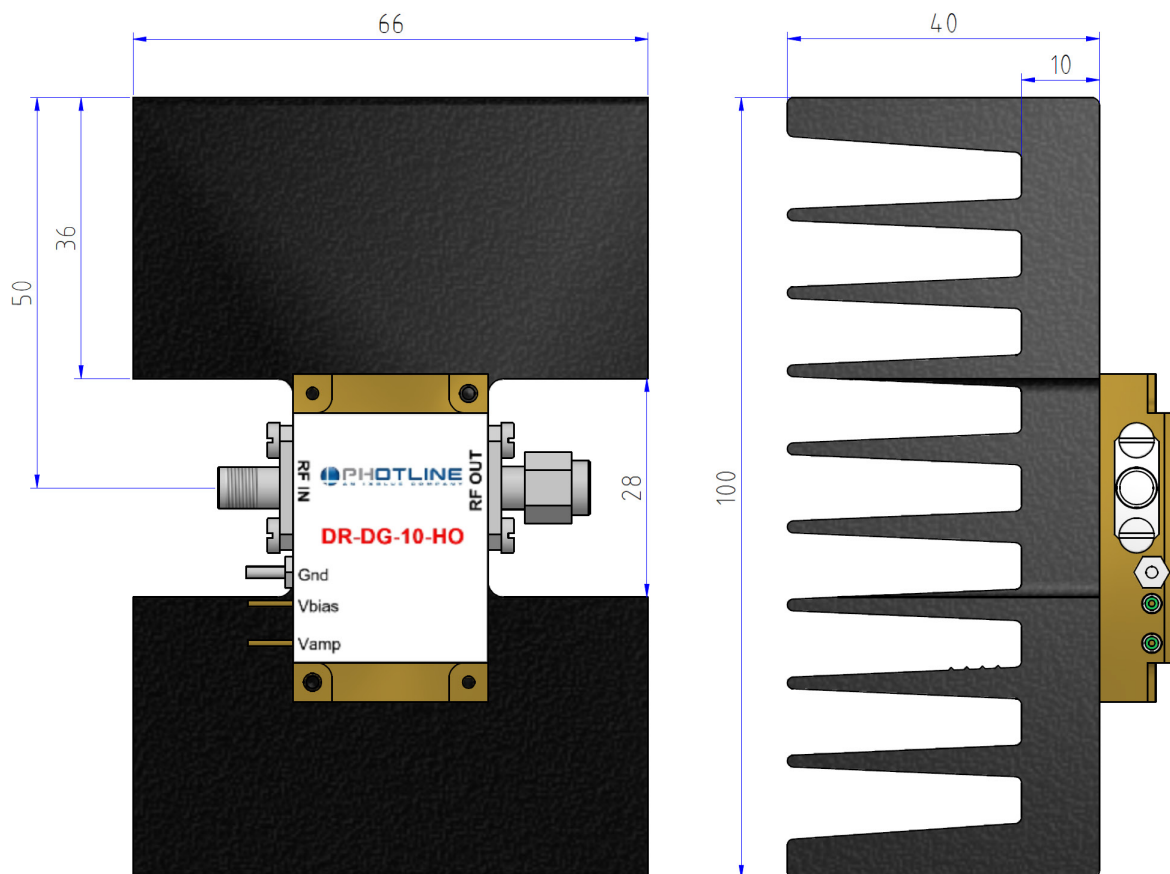

About us

iXBlue Photonics includes iXBlue iX Fiber brand that produces specialty optical fibers and Bragg gratings based fiber optics components and iXBlue Photline brand that provides optical modulation solutions based on the company lithium niobate (LiNbO₃) modulators and RF electronic modules.

iXBlue Photonics serves a wide range of industries: sensing and instruments, defense, telecommunications, space and fiber lasers as well as research laboratories all over the world.

3, rue Sophie Germain
25 000 Besançon - FRANCE
Tel. : +33 (0) 381 853 180 - Fax : + 33 (0) 381 811 557

iXblue reserves the right to change, at any time and without notice, the specifications, design, function or form of its products described herein. All statements, specification, technical information related to the products herein are given in good faith and based upon information believed to be reliable and accurate at the moment of printing. However the accuracy and completeness thereof is not guaranteed. No liability is assumed for any inaccuracies and as a result of use of the products. The user must validate all parameters for each application before use and he assumes all risks in connection with the use of the products